

compost

CARATTERISTICHE

characteristics / caractéristiques

- **Telaio rivestito con decorativo. Coprifilo esterno 9/10. Coprifilo interno 7/10. Guarnizione effetto tela per stipite porta a battente.**

EN I Cadre in decorative coated. Esternal casing 9/10 in decorative coated internal casing 7/10. Canvas effect gasket for swing door jamb.

FR I Cadre avec revêtement décoratif couvre-fils externe 9/10 avec revêtement décoratif. Couvre-fils interne 7/10. Joint effet de toile pour muissérie porte battante.

- **Due montanti in sandwich di abete, foderati in MDF e rivestiti con decorativo.**

EN I Two uprights in sandwiched fir, lined in MDF and covered with decor.

FR I Deux montants sandwich en sapin, doublés en MDF avec revêtement décoratif.

- **Pannello tamburato da 38 mm rivestito con decorativo.**

EN I The 38 mm hollow-core panel covered with decor.

FR I Panneau en nid d'abeilles de 38 mm avec revêtement décoratif.

- **Due montanti uniti ad un vetro VISARM ove incluso.**

EN I Two uprights assembled to VISARM 6/7 glass where included.

FR I Deux montants avec verre VISARM 6/7 si inclu.

- **Opzione: Quattroquattro con cerniere a scomparsa e serratura magnetica.**

EN I Option: Quattroquattro with concealed hinges and magnetic lock.

FR I Option: Quattroquattro avec charnières dissimulées et serrure magnétique.

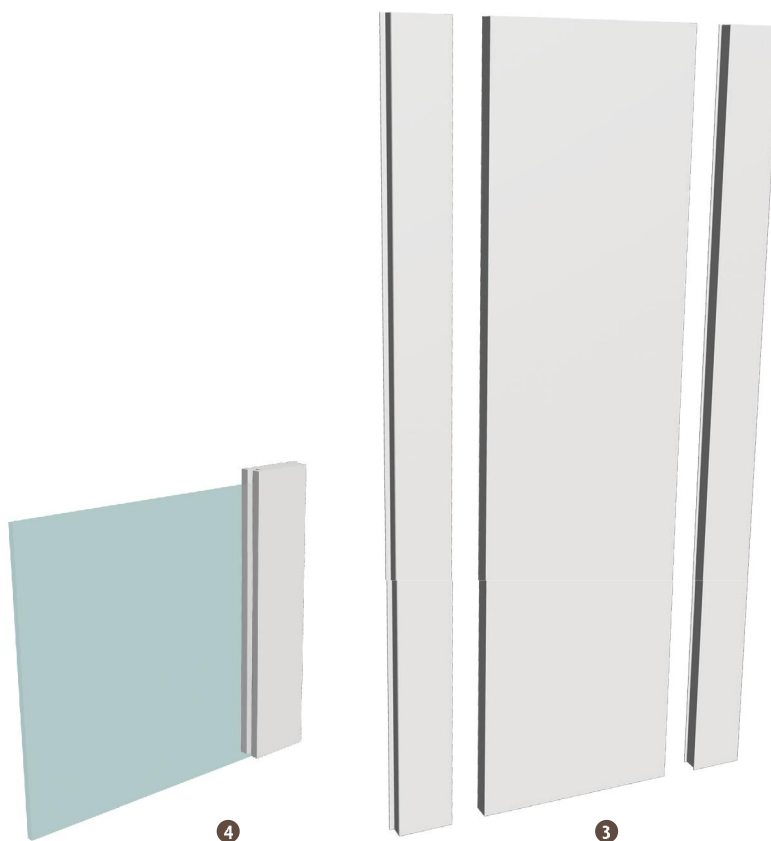
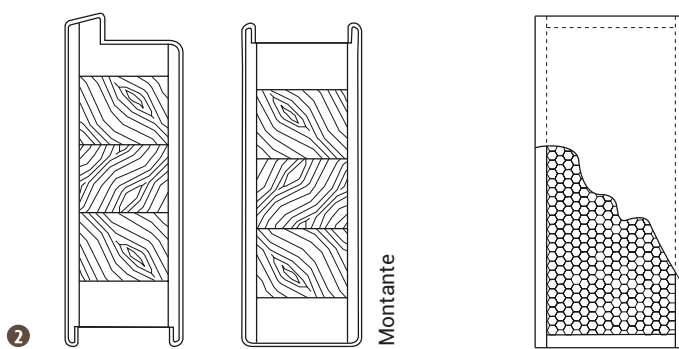
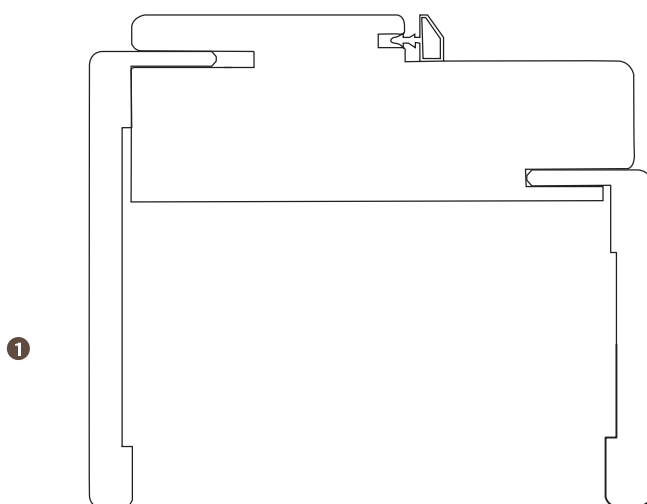



COMPOST
PW



COMPOST
GF



COMPOST 2i
RS



COMPOST 3i
NN



COMPOST 4i
GF



COMPOST 5i
NN



COMPOST VELA

● RG

Vetro latte / glass milk / verre de lait



COMPOST VELA P

● NN



● WN

Vetro latte / glass milk / verre de lait



● PW



● PW

Vetro latte / glass milk / verre de lait



● PW



COMPOST SOLE

● PW

Vetro latte / glass milk / verre de lait



COMPOST SATURNO

● NN

Vetro latte / glass milk / verre de lait



COMPOST GIOVE

● RS

Vetro latte / glass milk / verre de lait



COMPOST LUNA

● NCR

Vetro latte / glass milk / verre de lait



COMPOST VENERE

● WN

Vetro latte / glass milk / verre de lait



COMPOST VETRO

● NCR

Vetro visarm satinato / satin visarm
glass / verre dépoli visarm



COMPOST VETRO PA01

● NCR

Vetro "Picasso" / "Picasso" glass / "Picasso" verre



COMPOST VETRO A01

● NCR

Vetro "Kandisky" / "Kandisky" glass / "Kandisky" verre



COMPOST FV

● RG

Vetro visarm satinato / satin visarm glass / verre dépoli visarm



COMPOST FV STSAT

● RG

Vetro "Star" / "star" glass / "star" verre



COMPOST 2V

● NCR

Vetro satinato / glass satin / verre satiné



COMPOST 3iV

● PW

Vetro latte / glass milk / verre de lait

modello | model | modèle:

COMPOST











APERTURE

Opening | Ouverture [pag. 10/11]

-  BT
-  SC
-  SCE
-  LIBSIM
-  VNT
-  RT

FINITURE

Finishing | Finition [pag. 8/9]

-  NN
-  RS
-  WN
-  PW
-  NCR
-  GF
-  BF
-  RG
-  LA
-  RI
-  B





modello | model | modèle:

2i

APERTURE

Opening | Ouverture [pag. 10/11]



- BT
- SC
- SCE
- LIBSIM
- VNT
- RT

FINITURE

Finishing | Finition [pag. 8/9]



- NN
- RS
- WN
- PW
- NCR
- GF
- BF
- RG
- LA
- RI
- B





modello | model | modèle:

3i

APERTURE

Opening | Ouverture [pag. 10/11]



BT



SC



SCE



LIBSIM



VNT



RT

FINITURE

Finishing | Finition [pag. 8/9]



NN



RS



WN



PW



NCR



GF



BF



RG



LA



RI



B





modello | model | modèle:

5i

APERTURE

Opening | Ouverture [pag.10/11]



- BT
- SC
- SCE
- LIBSIM
- VNT
- RT

FINITURE

Finishing | Finition [pag.8/9]



- NN
- RS
- WN
- PW
- NCR
- GF
- BF
- RG
- LA
- RI
- B

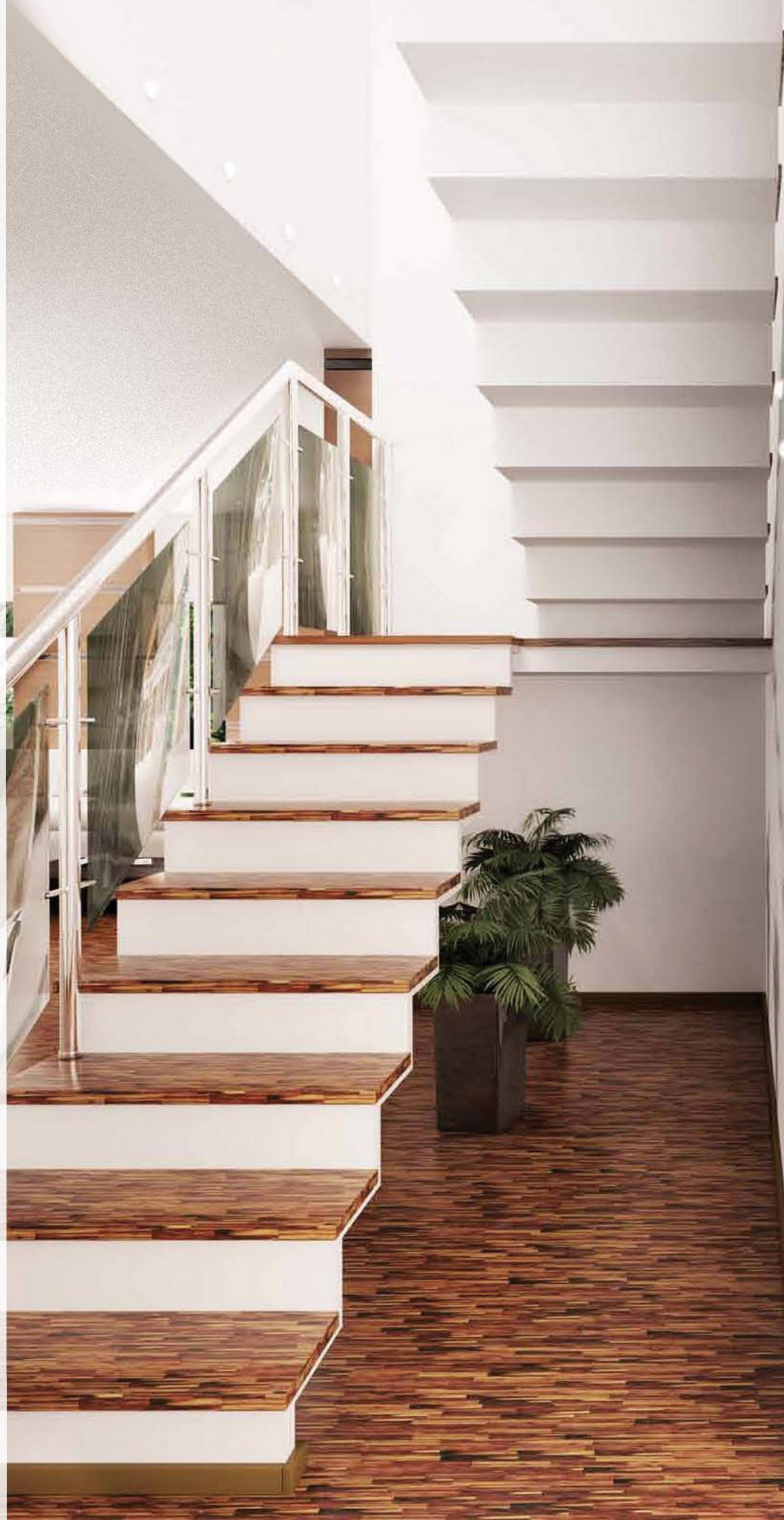



VETRI

Glasses | Vitrage | pag. 2/13



LVSAT



LVSAT5i



PA01



PB02



KA01



KB02



KLA01



KLB02

APERTURE

Opening | Ouverture | pag. 10/11



BT



SC



SCE

FINITURE

Finishing | Finition | pag. 8/9



NN



RS



WN



PW



NCR



GF



BF



RG



LA



RI



B





modello | model | modèle:

LIBRO

APERTURE
Opening | Ouverture [pag.10/11]



LIBSIM

FINITURE
Finishing | Finition [pag.8/9]



- NN
- RS
- WN
- PW
- NCR
- GF
- BF
- RG
- LA
- RI
- B





modello | model | modèle:

VETRO

VETRI

Glasses | Vitrage [pag. 2/13]



LVSAT



LVSAT5i



PA01



PB02



KA01



KB02



KLA01



KLB02

APERTURE

Opening | Ouverture [pag. 10/11]



BT



SC



SCE

FINITURE

Finishing | Finition [pag. 8/9]



NN



RS



WN



PW



NCR



GF



BF



RG



LA



RI



B





modello | model | modèle:
VELA

-  LVSAT
-  LVLVL

-  BT
-  SC
-  SCE
-  RT
-  VNT

-  NN
-  RS
-  WN
-  PW
-  NCR
-  GF
-  BF
-  RG
-  LA
-  RI
-  B

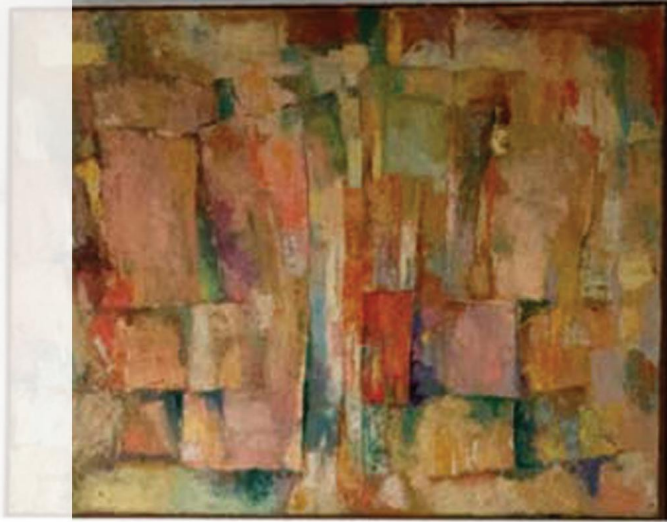



modello | model | modèle:

VELA P

APERTURE

Opening | Ouverture [pag. 10/11]



- BT
- SC
- SCE
- RT
- VNT

FINITURE

Finishing | Finition [pag. 8/9]



- NN
- RS
- WN
- PW
- NCR
- GF
- BF
- RG
- LA
- RI
- B



compost

modello | model | modèle:

3Q

VETRI

Glasses | Vitrage [pag. 2/13]



LVSAT



LVLVL

APERTURE

Opening | Ouverture [pag. 10/11]



BT



SC



SCE



RT



VNT

FINITURE

Finishing | Finition [pag. 8/9]



NN



RS



WN



PW



NCR



GF



BF



RG



LA



RI



B





modello | model | modèle:
3QP

APERTURE

Opening | Ouverture [pag.10/11]

- BT
- SC
- SCE
- RT
- VNT

FINITURE

Finishing | Finition [pag.8/9]

- NN
- RS
- WN
- PW
- NCR
- GF
- BF
- RG
- LA
- RI
- B





compost

VETRI

Glasses | Vitrage | pag. 12/13



LVSAT



LVLVL

modello | model | modèle:

SOLE

APERTURE

Opening | Ouverture | pag. 10/11



BT



SC



SCE



RT



VNT

FINITURE

Finishing | Finition | pag. 8/9



NN



RS



WN



PW



NCR



GF



BF



RG



LA



RI



B





compost

modello | model | modèle:

LUNA

VETRI

Glasses | Vitrage [pag. 2/13]



LVSAT



LVLVL

APERTURE

Opening | Ouverture [pag. 10/11]



BT



SC



SCE



RT



VNT

FINITURE

Finishing | Finition [pag. 8/9]



NN



RS



WN



PW



NCR



GF



BF



RG



LA



RI



B





compost

VETRI
Glasses | Vitrage | pag. 2/13



LVSAT
LVLVL

APERTURE
Opening | Ouverture | pag. 10/11



BT
SC
SCE
RT
VNT

FINITURE
Finishing | Finition | pag. 8/9



NN
RS
WN
PW
NCR
GF
BF
RG
LA
RI
B

modello | model | modèle:

GIOVE





compost

modello | model | modèle:

VENERE

VETRI

Glasses | Vitrage [pag. 2/13]



LVSAT



LVLVL

APERTURE

Opening | Ouverture [pag. 10/11]



BT



SC



SCE



RT



VNT

FINITURE

Finishing | Finition [pag. 8/9]



NN



RS



WN



PW



NCR



GF



BF



RG



LA



RI



B





modello | model | modèle:

SATURNO

VETRI

Glasses | Vitrage [pag. 2/13]

-  LVSAT
-  LVLVL

APERTURE

Opening | Ouverture [pag. 10/11]

-  BT
-  SC
-  SCE
-  RT
-  VNT

FINITURE

Finishing | Finition [pag. 8/9]

-  NN
-  RS
-  WN
-  PW
-  NCR
-  GF
-  BF
-  RG
-  LA
-  RI
-  B



